

PLUG

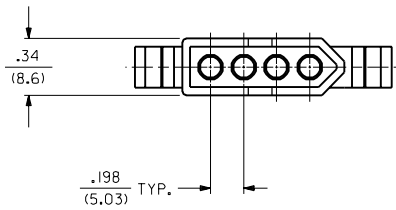
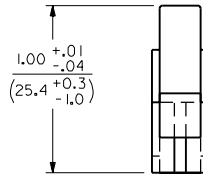
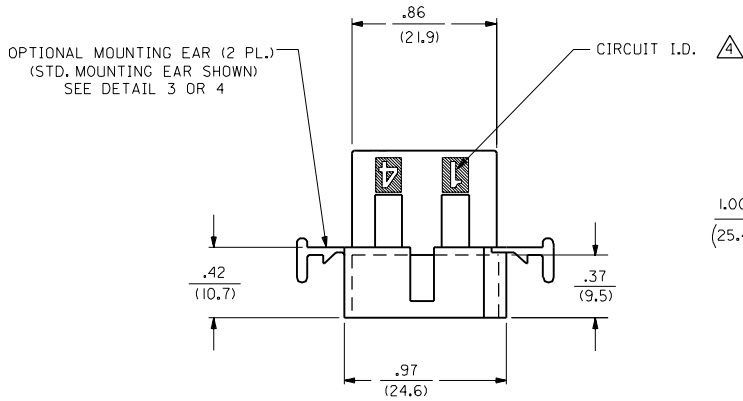
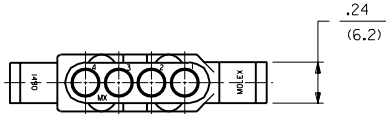

PLUG HOUSING

T	3	T
S	2	T
RI	1	T
R		
P		
MFG.	SH.	REV.
LTR.		REVISIONS

DIMENSIONS SHOWN (METRIC) INCH		▽ = 0	▼ = 0	REVISE ONLY ON CAD SYSTEM
UNLESS OTHERWISE SPECIFIED TOLERANCES: ANGULAR ± .001		TITLE		
INCH METRIC		.093/(2.36) HOUSING, PLUG AND RECEPTACLE, 4 CKT. ± .198/(5.03) CTRS.		
3 PLACE ± .010	---	PART NO. MOLEX INCORPORATED SHEET NO. DATE		
2 PLACE ± .014	± 0.25	L15LEJLL. 60532 U.S.A. 1 OF 3 3/9/88		
1 PLACE ---	± 0.35	SEE CHART DRWG. NO. SD-1490-*		
DRAFT WHERE APPLICABLE MUST REMAIN WITHIN DIMENSIONS		THIS DRAWING CONTAINS INFORMATION THAT IS PROPRIETARY TO MOLEX INC. AND SHOULD NOT BE USED WITHOUT WRITTEN PERMISSION.		
DRWG. BY: CEP	CHKD. BY: RW	FILE NAME: SD1490X1.DWG	SCALE: 2 : 1	SIZE: CP
APP'D. BY: RAS				

PLUG		RECEPTACLE	
PART NO.	ENG. NO.	PART NO.	ENG. NO.
03-09-2041	I490-P	03-09-1041	I490-R
03-09-2042	I490-P1	03-09-1042	I490-R1
03-09-7041	I490-PBK	03-09-6041	I490-RBK
03-09-7042	I490-P1BK	03-09-6042	I490-R1BK
PRELIMINARY	I490-P2	03-09-1043	I490-R2
03-09-3042	I490-P1BU	03-09-6043	I490-RBU
		03-09-6045	I490-RGN

LEGEND:

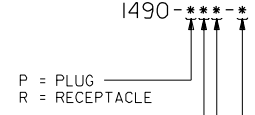

- P = PLUG
R = RECEPTACLE
- BLANK = WITH STANDARD EARS
1 = WITHOUT EARS
2 = WITH PREBENT EARS, PER DETAIL 4

- COLOR: BLANK=NATURAL COLOR
AM=AMBER BK=BLACK BU=BLUE
BN=BROWN CY=GRAY GN=GREEN
OR=ORANGE RD=RED YW=YELLOW
- BLANK = MATERIAL CODE A

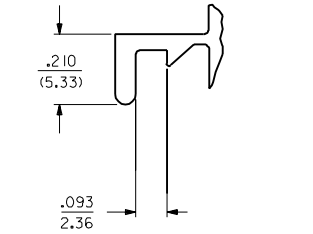

DETAIL 3

.093/(2.36) STANDARD MOUNTING EAR (SCALE 4:1)

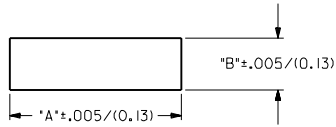
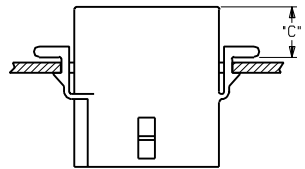

HOUSING	DIM. "A"	DIM. "B"	DIM. "C"
PLUG	1.131/(28.73)	.375/(9.52)	.36/(9.1)
RECEPTACLE	1.038/(26.36)	.312/(7.92)	.37/(9.4)

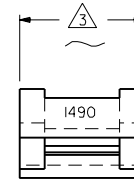

DETAIL 4

.093/(2.36) PREBENT MOUNTING EAR (SCALE 4:1)

NOTES:

- MATERIAL CODES:
A = NYLON 6/6, 94V-2
- THIS PART COMPLIES WITH MOLEX PRODUCT SPEC. 02-09.
- FOR DIMENSION SEE SHEET 1 AND 2.
- CIRCUIT I.D. NUMBERS ON HOUSING APPEAR ON PARTS FROM TOOLS BUILT AFTER 8/7/91.

DIMENSIONS SHOWN (METRIC) INCH		▽=0 ▼=0		REVISE ONLY ON CAD SYSTEM	
UNLESS OTHERWISE SPECIFIED TOLERANCES ANGLES ARE ± .005					
INCH		METRIC			
3 PLACE	± .010	---	---		
2 PLACE	± .014	± 0.25	---		
1 PLACE	---	± 0.35	---		
DRAFT WHERE APPLICABLE MUST REMAIN WITHIN DIMENSIONS					
DRWG. BY	CEP	CHK'D. BY	RW		
APP'D. BY	RAS	SCALE	2 : 1		
LTR.	REVISIONS	LTR.	REVISIONS		

TITLE		.093/(2.36) HOUSINGS, PLUG AND RECEPTACLE, 4 CKT., .198/(5.03) CTRS.	
MOLEX INCORPORATED	SHEET NO.	DATE	
LITTLE ROCK, U.S.A.	3	3/10/88	
PART NO.	SD-1490-#		
SEE CHART			
FILE NAME	SD1490X3	DIV.	SIZE
DCN		CP	C